

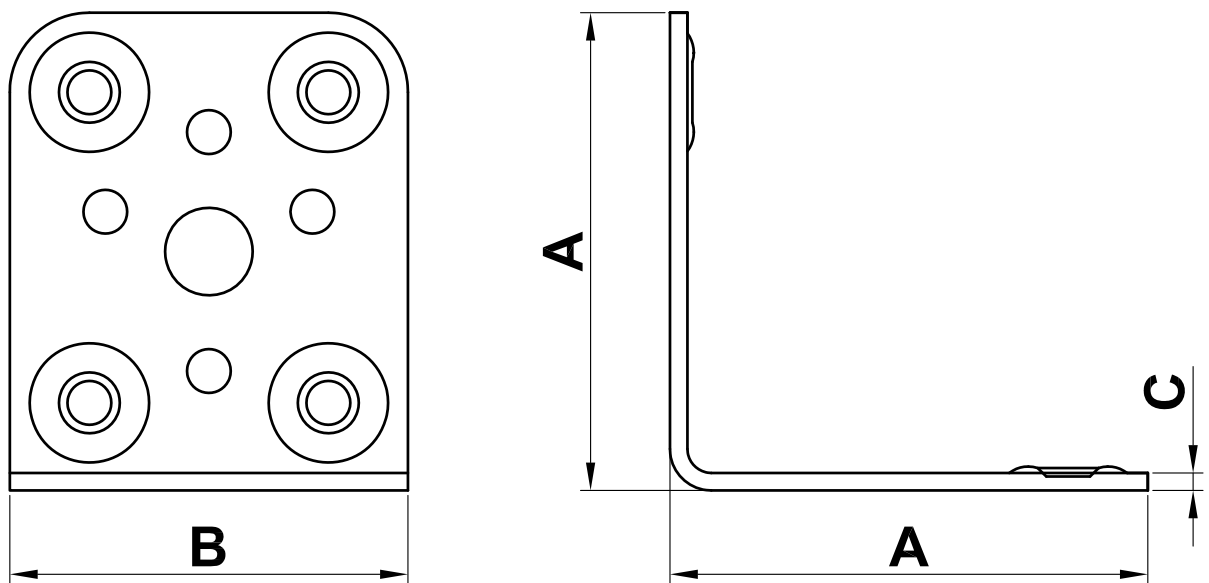

## Angulo Mod. 300



A (mm)	B (mm)	C (mm)
40	50	2.2
60	50	2.2
80	50	2.2
100	50	2.2